

Instant EtherFast® Series

# EtherFast® 10/100 PC Cards



*Use this guide to install:*

*EtherFast 10/100  
PC Card (PCMPC100 v3)*

*EtherFast 10/100 Integrated  
PC Card (PCM100 v2)*

**User Guide**

**LINKSYS®**

#### COPYRIGHT & TRADEMARKS

Copyright © 2001 Linksys, All Rights Reserved. EtherFast is a registered trademark of Linksys. Microsoft, Windows, and the Windows logo are registered trademarks of Microsoft Corporation. All other trademarks and brand names are the property of their respective proprietors.

#### LIMITED WARRANTY

Linksys guarantees that every EtherFast 10/100 PC Card is free from physical defects in material and workmanship under normal use for FIVE years from the date of purchase. If the product proves defective during this warranty period, call Linksys Customer Support in order to obtain a Return Authorization Number. BE SURE TO HAVE YOUR PROOF OF PURCHASE ON HAND WHEN CALLING. RETURN REQUESTS CANNOT BE PROCESSED WITHOUT PROOF OF PURCHASE. When returning a product, mark the Return Authorization Number clearly on the outside of the package and include your original proof of purchase.. All customers located outside of the United States of America and Canada shall be held responsible for shipping and handling charges.

IN NO EVENT SHALL LINKSYS' LIABILITY EXCEED THE PRICE PAID FOR THE PRODUCT FROM DIRECT, INDIRECT, SPECIAL, INCIDENTAL, OR CONSEQUENTIAL DAMAGES RESULTING FROM THE USE OF THE PRODUCT, ITS ACCOMPANYING SOFTWARE, OR ITS DOCUMENTATION. Linksys makes no warranty or representation, expressed, implied, or statutory, with respect to its products or the contents or use of this documentation and all accompanying software, and specifically disclaims its quality, performance, merchantability, or fitness for any particular purpose. Linksys reserves the right to revise or update its products, software, or documentation without obligation to notify any individual or entity. Please direct all inquiries to:

Linksys P.O. Box 18558, Irvine, CA 92623.

#### FCC STATEMENT

The EtherFast 10/100 PC Cards have been tested and found to comply with the limits for a Class B digital device, pursuant to Part 15 of the FCC Rules. These limits are designed to provide reasonable protection against harmful interference in a residential installation. This equipment generates, uses, and can radiate radio frequency energy and, if not installed and used according to the instructions, may cause harmful interference to radio communications. However, there is no guarantee that interference will not occur in a particular installation. If this equipment does cause harmful interference to radio or television reception, which is found by turning the equipment off and on, the user is encouraged to try to correct the interference by one or more of the following measures:

- Reorient or relocate the receiving antenna
- Increase the separation between the equipment or device
- Connect the equipment to an outlet other than the receiver's
- Consult a dealer or an experienced radio/TV technician for assistance

UG-PCMPC100v3-010509A-AC

# Table of Contents

Introduction	1
The Linksys EtherFast 10/100 Cards	1
About Fast Ethernet	2
Package Contents	3
Getting to Know the EtherFast 10/100 PC Cards	4
LEDS / The RJ-45 Port	4
Installing the EtherFast 10/100 PC Cards	5
Getting the Right Cable / Installing the PC Card and Cabling	5
About the Software / Choosing I/O and IRQ Values	6
Socket and Card Services	7
How to Use the 10/100 PC Card's Enabler for DOS-Based Network	8
Network Driver Setup	9
Windows 95 Installation and Setup	10
Windows 98 Installation and Setup	16
Windows Millennium Installation and Setup	22
Windows NT 4.0 Installation and Setup	25
Windows 2000 Installation and Setup	35
Troubleshooting	39
Appendix	42
Sharing Your Files and Printers	42
Novell NetWare 3.x Client Setup for Windows 98 or 95	44
Windows 98 or 95 Client for Windows NT	45
Starting Over in Windows 95, 98, or 2000	46
Manually Installing the Network Components in	
Windows 95 and Windows 98	51
Linux, Open Source, and Beta Operating Systems	52
Twisted-Pair Cabling	53
Crimping Your Own Network Cables	54
Specifications	55
Linksys Warranty Information	57

# Introduction

## The Linksys EtherFast 10/100 PC Cards

Welcome to the world of convenient and flexible notebook PC networking! The EtherFast 10/100 PC Cards allow you to connect with virtually any Ethernet-based network or Internet connection including: Cable modem, DSL modem, and more. Sharing files and printers has never been easier, and their single-slot designs are perfect for slim notebooks--freeing up your additional slots for use with other accessories.

Whether you choose the convenience of the standard PC card, with its removable media coupler, or the Integrated PC Card and it's all-in-one design, you'll get fast file transfers, hot-swap capability\*, and bus mastering. Compatible with PCMCIA-equipped notebook PCs, the 10/100 PC Cards offer Minimal voltage consumption and an automatic sleep mode to help conserve your notebook PC's battery life.

The 10/100 PC Cards also automatically adjust their speed to optimize data trafficking. Virtually all brand name PCs and major operating systems, including Windows 95, 98, 2000, Millennium, and NT are supported. Convenience and Flexibility--that's what makes the EtherFast 10/100 PC Cards the ultimate networking solution for your notebook PC.

\*When used with Plug-and-Play Operating Systems

## About Fast Ethernet

In recent years, Fast Ethernet has emerged as the fastest growing network topology around. Operating at an incredible 100 million bits per second (100Mbps), and sometimes referred to as 100BaseTX, Fast Ethernet is more than fast enough to handle the latest speed-dependent applications like video, multimedia, and Internet connectivity.

Fast Ethernet is ten times faster than regular Ethernet networks. Also known as 10BaseT, regular Ethernet networks typically run at 10Mbps.

Unfortunately because of their speed and other technological differences, Ethernet and Fast Ethernet cannot be readily mixed together in most cases. A 10BaseT network adapter, for example, cannot be attached directly to a Fast Ethernet network. In environments where 10BaseT and Fast Ethernet need to be mixed together - in migration scenarios, for example, where file servers are moved to 100Mbps speeds for better performance - a switch or a dual-speed hub can be used to connect network segments of disparate speeds together.

The EtherFast 10/100 PC Cards will run with both 10BaseT and 100BaseTX networks without any special settings, allowing you to plug into virtually any network while at the office or on the road, regardless of speed. When a network cable is plugged in, the EtherFast Card automatically determines the speed, duplex, and polarity of the arriving network packets and adjusts itself accordingly. Also known in the industry as NWAY, this "live wire" ability also allows network cables to be swapped\* with the EtherFast Card while it's turned on--the card will automatically reconnect itself to the network as soon as a new cable is plugged in.

\*When used with Plug-and-Play Operating Systems

## Package Contents for the EtherFast 10/100 Integrated PC Card (PCM100 V2)



- EtherFast 10/100 PC Card
- One Driver Disk
- One User Guide and Registration Card

## Package Contents for the EtherFast 10/100 PC Card (PCMP100 V3)



- EtherFast 10/100 PC Card
- One Dongle Cord
- One Driver Disk
- One User Guide and Registration Card

# Getting to Know the EtherFast 10/100 PC Cards

## LEDs

Link	The LED will illuminate when the card is successfully connected to a network.
Act	The Activity LED will flicker when data is being transmitted or received over the network.
10/100	This LED will be illuminated when the card is operating at 100Mbps; dormant when operating at 10Mbps.

## The RJ-45 Port

The RJ-45 Port is where you will connect your Category 3 or 5 network cabling. Refer to the section on Twisted Pair Cabling for detailed information on network cabling.

# Installing the EtherFast 10/100 PC Cards

## Getting the Right Cable

Like most network devices, the EtherFast Card must be connected to a 10BaseT or Fast Ethernet hub with the right kind of twisted-pair network cabling. Although twisted-pair is available in different styles and grades, this installation requires a category 5 network cable with RJ-45 connectors, not exceeding 100 meters (328) feet in length. Cabling can be obtained at most computer stores. If you are using Fast Ethernet, Category 5 (or better) cable must be used. For more information about Fast Ethernet cabling, including information on how to crimp your own cables, go to the *Crimping Your Own Network Cables* section of the Appendix.

## Installing the PC Card and Cabling

1. Turn off your PC.
2. If you are installing the standard PC Card, connect the flat end of the media coupler to the EtherFast 10/100 PC Card. It should lock firmly into place.
3. Locate your PC's PCMCIA slot (usually located on the side). Slide the EtherFast 10/100 PC Card into the slot with the triangle on the card facing up. The 128-pin end goes in first. Make sure that the card is seated snugly in place.

*Note: If the PC Card does not fit all the way into the slot, check your PC's documentation to be sure that your laptop has a PCMCIA slot.*

4. Attach one end of a UTP category 5 network cable into the RJ-45 port on the end of the EtherFast Card or media coupler. Then plug the other end of the cable into a Fast Ethernet or 10BaseT network device. The EtherFast 10/100 PC Card will automatically sense the type, polarity, and speed of your network's cabling and adjust itself accordingly.

## About the Software

The EtherFast 10/100 PC Card requires two different kinds of software in order to work:

Socket and card services are special software drivers that allow a PC card to communicate with your computer. Your computer might have services that were installed by the manufacturer, making your PC compatible with a wide range of CardBus and PCMCIA cards. If your computer doesn't have services, or if you're not sure how to get yours working, the EtherFast 10/100 PC Card comes with a generic enabler you can use to get the card up and running in your DOS or Windows NT computer's card slot. Card services are always loaded into memory each time your PC is started up, and always before your network drivers are loaded.

Network drivers allow the card to communicate with your network at large. The EtherFast 10/100 PC Card disk includes drivers for many network operating systems, including Windows 95, 98, 2000, Millennium, NT, Windows for Workgroups, NetWare, packet driver networks, and more. When the EtherFast 10/100 PC Card is up and running, it will talk to your PC's card slot, which will talk to the Card services, which will finally talk to the network drivers and the network at large.

## Choosing I/O and IRQ Values

Just like modems, mice, CD-ROMs, hard drives, and other devices, the EtherFast 10/100 PC Card requires an I/O address and an IRQ value.

An I/O base address is the Input/Output area of your computer's Input/Output range that the EtherFast 10/100 PC Card will use for transferring data to and from a network. The I/O value you assign to the EtherFast 10/100 PC Card must not be in use by any other devices. I/O values are always expressed in hexadecimal values. A hexadecimal value is basically a number that serves as an abbreviation of a larger number.

Also known as an interrupt, an IRQ is a signal that notifies the PC when certain input or output events have occurred and where the attention of the PC is needed. IRQs are expressed in numerical values. Your computer's system BIOS will automatically assign an IRQ value.

*Note: Plug-and-Play operating systems like Windows 98, Windows 95 OSR2, (also known as Windows 95 Version B) Millennium, and 2000 will usually assign available I/O and IRQ values to the EtherFast 10/100 PC Card automatically, making the card's installation quick and easy.*

If you can't seem to find an I/O address or interrupt value to use, contact your PC's manufacturer to determine which values are currently available for use with the EtherFast 10/100 PC Card.

## Socket and Card Services

Socket and card services allow your computer to recognize a PCMCIA card when it is inserted into your PC's PCMCIA slot. Your PC will need some kind of services installed in order to use the EtherFast 10/100 PCMCIA PC Card.

Most PCMCIA-equipped PCs have socket and card services pre-installed by the computer's manufacturer. If you are upgrading your PC by adding a new PCMCIA slot, then you need to upgrade your services as well. You have two choices:

- **Use Built-in Services in the Driver**

If your computer doesn't have services (or you don't know what kind are installed), you may be able to use the enabler built into the driver of the PCMCIA Card for DOS or NT computers. The enabler tries to automatically get the card recognized by the laptop and enable the slot to work with the 10/100 PC Card only.

- **Contact Your PC's Manufacturer**

If your computer doesn't have services, and the generic services contained in the 10/100 PC Card's driver don't seem to work with your PC, contact your computer's manufacturer to find out what kind of services your computer uses, or how to get compatible services if your computer doesn't have them.

*Note: Plug-and-Play operating systems like Windows 95, 98, Millennium, and 2000 have socket and card services built into the operating system. You don't need to install them if you are using these Operating Systems.*

## How to Use the 10/100 PC Card's Enabler for DOS-Based Network Operating Systems

The software disk provided with the EtherFast 10/100 PC Card includes generic socket and card services built into the driver that can be used to enable the EtherFast 10/100 PC Card. The card's hardware-specific client enabler will only enable the EtherFast 10/100 PC Card. If you want to use other PCMCIA cards in the future, you will need to obtain additional services for those card(s) before you'll be able to use them.

When enabler loads itself into memory, it tries to choose IRQ and I/O base address values for the EtherFast 10/100 PC Card not already in use.

Enabler also checks to see if any other service packages are loaded. If there are any services already present in memory, enabler will attempt to load itself without disturbing them.

Open up your config.sys file in a text editor. Scroll through the file. Find the line that reads (or is similar to) the following:

```
DEVICE=C:\EMM386.EXE
```

*Note: When loading the enabler, it must be saved in the autoexec.dat.*

It will probably be located near the beginning of the file. You will need to add a command to the end of the EMM386 command in order to reserve an area of memory for the 10/100 PC Card's client enabler to use.

Add the following command to the end of the EMM386 line:

```
NOEMS X=D000-D3FF
```

so that the new EMM386 line now looks something like this (it may vary slightly):

```
DEVICE=C:\EMM386.EXE NOEMS X=D000-D3FF
```

If there are already commands on the EMM386 line, try not to disturb them when you add the NOEMS X=D000-D3FF

*Note: Plug-and-Play operating systems such as Windows 95, 98, 2000, and Millennium do not require the use of the enabler or memory exclusion.*

## Network Driver Setup

Follow these instructions carefully. You can view or print the setup directions from your favorite word processor. For the operating systems not covered in this user guide, insert the program disk into your PC. The supported Operating Systems not covered in this User Guide have subdirectories that contain "read me" instructions. These DOS-based Operating Systems are listed below.

A:\NETWARE	NetWare Client (DOS ODI) NetWare Lite Personal NetWare Sun PCNFS (with ODI drivers)
A:\PKTDRV	Packet Driver
A:\WFW311	Windows for Workgroups 3.11
A:\NDIS2	NDIS support Lantastic Sun PCNFS (with NDIS drivers) Microsoft LAN Manager



# Windows 95 Installation and Setup

## Overview

Follow the instructions below to install your EtherFast 10/100 PC Card on Microsoft Windows 95. After installing the EtherFast 10/100 PC Card hardware in your computer, follow the instructions below to install the EtherFast 10/100 PC Card's Windows 95 network driver from the card's driver disk.

The standard 16-bit PC Card standard is a Plug and-Play network adapter that is designed to be automatically detected by Windows 95 as soon as you insert it into your computer.

There are currently three versions of Windows 95:

- Windows 95 (the first release)
- Windows 95 version **A**
- Windows 95 version **B**, also called OSR2

Please keep in mind that the installation procedure for the network driver will vary slightly depending on the edition of Windows 95 OSR2 you are using and your current system configuration.

To install the network driver, start up your computer.

**Note:** Screen shots used in this *Installation and Setup* section are from installation of the standard EtherFast 10/100 PC Card v3 (PCMP100 v3). If you are installing the EtherFast 10/100 Integrated PC Card v3 (PCM100 v2), the installation process will be unchanged, however, the product name will be different.

1. Windows 95 will automatically detect the presence of the EtherFast 10/100 PC Card in your computer. If Windows 95 goes directly to the windows desktop and does not display the *Update Device Driver* window, refer to the Troubleshooting section.

2. While the *Update Device Driver Wizard* window is visible, put the Linksys EtherFast 10/100 PC Card Driver Disk into the floppy drive and click the **Next** button.

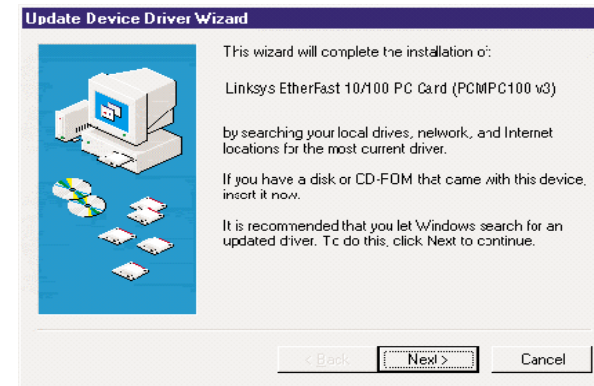

3. Windows will begin searching your floppy drive for the correct device drivers. A message will appear stating that Windows found the driver for the *Linksys EtherFast 10/100 PC Card (PCMP100 v3)*. Click the **Finish** button.



If Windows cannot find the driver for the card, refer to the Troubleshooting section.

4. Windows 95 will begin copying a number of files onto your computer. If Windows asks you to supply your original Windows 95 installation or setup files, insert your Windows CD-ROM or disks as needed, and direct Windows 95 to the proper location, (e.g., "D:\win95", "C:\windows\options\cabs"). Click the **OK** button.



If Windows asks you to supply a file containing the letters “pc100”, type “a:\” in the box that pops up as shown below. Click the **OK** button.

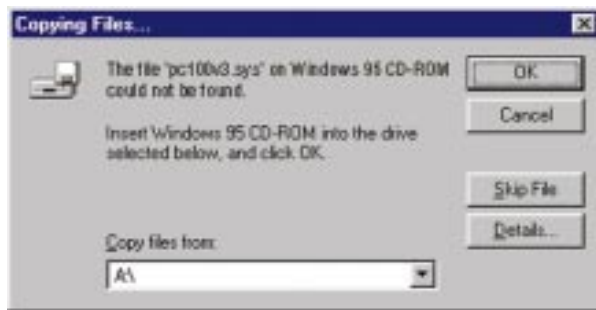

During the installation, Windows may ask you for a computer and work-group name. If so, refer to steps 9 and 10 in this section. Otherwise, continue with the installation.

Windows will finish copying all of the necessary files to your system. When asked if you want to restart your computer, click the **No** button.

Once you are back at the Windows 95 desktop, click on the **Start** button. Click on **Settings**, then **Control Panel**.

5. Double-click on the **Network** icon. The Network window will appear. Click on the **Configuration** tab.

6. Make sure that the following network components are installed:

*Client for Microsoft Networks*  
*Linksys EtherFast 10/100 PC Card (PCMPC100 V3)*  
*TCP/IP*

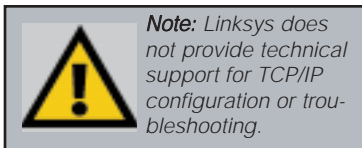

If other components are listed, this is fine. However, if any components are missing, you'll need to install them manually. Refer to *Manually Installing the Network Components* section.

If you need to install the **TCP/IP protocol**, refer to your system administrator or your Windows 95 documentation. Linksys does not provide technical support for the configuration or troubleshooting of the TCP/IP protocol.

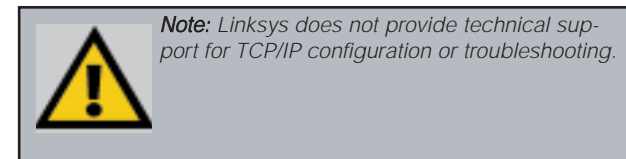

7. In the Primary Network Logon box, make sure that **Client for Microsoft Networks** is selected from the pull down menu. When you reboot, you will be prompted for a user name and password for Microsoft Networking.

8. To enable File and Printer Sharing, click on the **File and Print Sharing** button, then put a check mark next to both boxes in the window. Click the **OK** button.

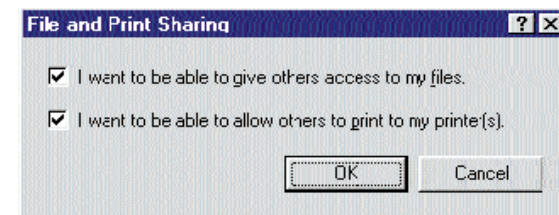

9. Click on the **Identification** tab. Type the name of your computer in the “Computer name” box. Make up a name that is unique from all the other computers’ names on the network. (e.g., Dino, Alpha, etc.)



10. Type the name of your workgroup in the “Workgroup” box. The name you type should be the same workgroup name in use by all of the other PCs on the network. Make sure to use the same case that is used on your other computers.

11. Enter a description of your computer in the “Computer Description” box. *This box is optional.*

12. *Optional:* Click on the **Access Control** tab. Make sure that *Shared-level access control* is selected. If the setting is on *User-Level access control* and you can’t change it, refer to the Troubleshooting section.

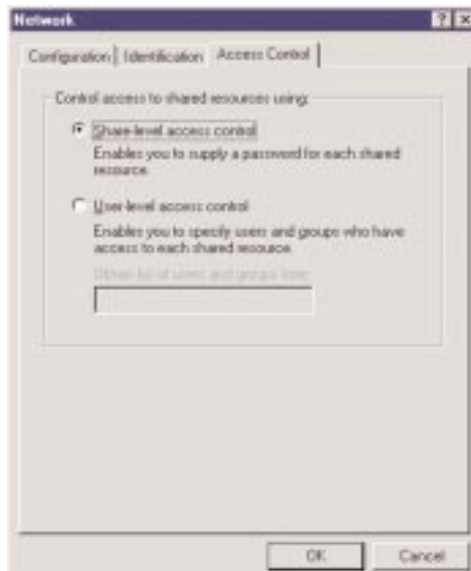

13. Click on the **OK** button. If your system asks you for your Windows 95 CD-ROM or the location of the 95 installation files, direct Windows to the appropriate location, (e.g., “D:\win95”, “C:\windows\options\cabs”).

14. Once Windows is done copying the necessary files, the *System Settings Change* window appears. Remove all disks from your computer and click on the **Yes** button to restart your PC.

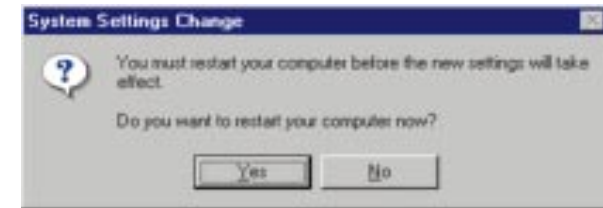

- If you don't see this window, simply close down Windows 95 and restart your computer by clicking on the **Start** button, then **Shut Down**, select **Restart the Computer**, then click the **Yes** button. The installation is complete. Remember to remove the Driver Disk from the floppy drive.

15. Once the computer has restarted, look at the EtherFast Card's LEDs. If your cabling is properly attached and the network is detected, the green Link light will be on, and the Activity (ACT) light will be flickering or solid.

16. A Logon window will appear. Make up a username and password and click **OK**. Do not click the **Cancel** or **Esc** button, or you won't be able to log onto the network. If the logon does not appear or if it does not allow you to log on, refer to the Troubleshooting section.

17. Once you are at the Windows 95 desktop, double-click on the **Network Neighborhood** icon. You should see an icon for the **Entire Network**, and/or the names of the other PCs on the network. In order to see your other computers and shared resources in **Network Neighborhood**, you need to enable *File and Printer Sharing*. For help, refer to *Sharing Your Files and Printers* in the Appendix .

*If you don't see anything at all*, press the F5 key on your keyboard a few times to refresh the screen.

*If you only see your computer in Network Neighborhood, if you only see computers that are running the same operating system as you and you don't see any others, or if you see all computers on the network except yours, and the other PCs can't see your computer*, refer to the Troubleshooting section.

# Windows 98 Installation and Setup

## Overview

After installing the EtherFast 10/100 PC Card hardware in your computer, follow these instructions to install the EtherFast 10/100 PC Card's Windows 98 network driver from the card's driver disk.

**Note:** Screen shots used in this Installation and Setup section are from installation of the standard EtherFast 10/100 PC Card (PCMP100 v3). If you are installing the EtherFast 10/100 Integrated PC Card (PCM100 v2), the installation process will be unchanged, however, the product name will be different.

Please keep in mind that the installation procedure for the network driver will vary slightly depending on the version of Windows 98 you are using and your current system configuration.

## Installing the PC Card's Driver

To install the network driver, Start up your computer.

1. The *Add New Hardware Wizard* window will appear. Click the **Next** button. If Windows 98 goes directly to the windows desktop and does not display this window, refer to the Troubleshooting section.

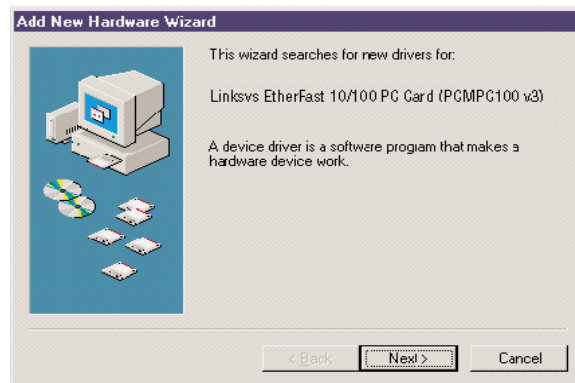

2. While the Update Device Driver Wizard window is visible, put the EtherFast 10/100 PC Card Driver Disk into the floppy drive and click the **Next** button. A window will appear and ask *What do you want Windows to do?*



3. Select *Search for the best driver for your device (Recommended)*. Click the **Next** button.
4. A window will appear asking where you would like Windows 98 to search for the driver. Select "Specify a location" and enter **A:\Win98** into the drop-down box. Click **Next** to continue.



5. Windows will begin searching your drives for the correct device drivers. Once Windows has located the driver, the window below will appear indicating that it located the *Linksys EtherFast 10/100 PC Card v3 (PCMP100 v3)*. Click **Next**.

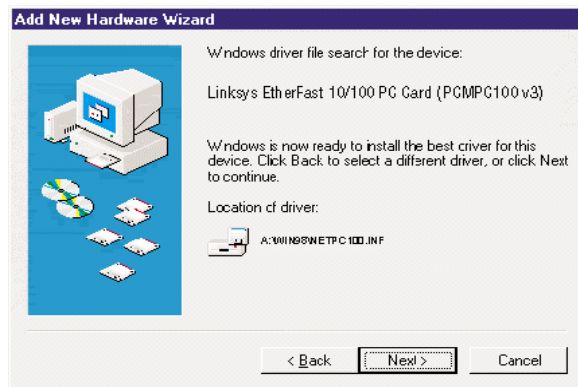

**Note:** DO NOT press **Skip** or **Cancel** at any time during the installation. Doing so will prevent your driver from being properly installed on your PC.

If Windows cannot find the driver for the card, refer to the Troubleshooting section.

6. Windows 98 will begin copying a number of files onto your computer. If Windows asks you to supply your original Windows 98 installation or setup files, insert the CD-ROM or disks as needed, and direct Windows 98 to the proper location, (e.g., C:\windows\options\cabs, D:\win98, or the *appropriate drive letter* of your CD-ROM drive). If Windows asks you to supply a driver that contains the letters "PC100", type "a:\win98" in the box that pops up. Click **OK**.

During the installation, Windows may ask you for a computer and workgroup name. If so, refer to steps 11-13 in this section. Otherwise, continue with the installation. Windows will finish copying all of the necessary files to your system. Click **Finish**.

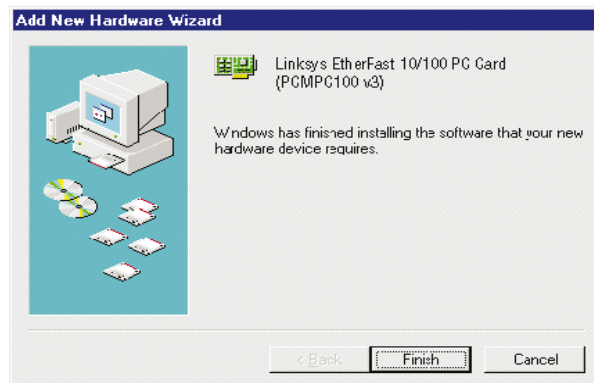

When asked if you want to restart your computer, click **No**. Once you are back at the Windows 98 desktop, click on the **Start** button, click **Settings**, then **Control Panel**.

7. Double-click on the **Network** icon. The Network window will appear. Click on the **Configuration** tab.

8. Make sure that the following network components are installed:

*Client for Microsoft Networks*  
*Linksys EtherFast 10/100 PC Card (PCMP100 V3)*  
*TCP/IP*

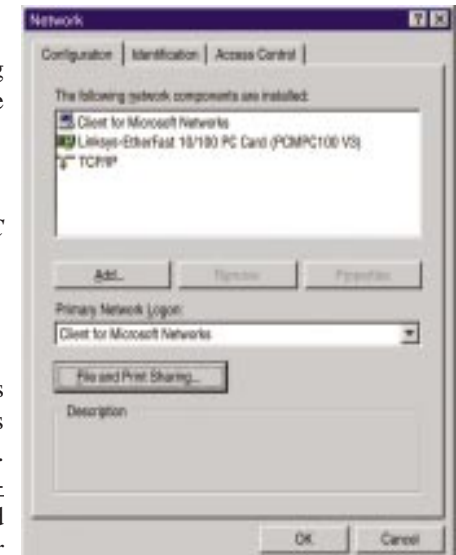

There may be other components listed in addition to the ones shown above. This is fine. However, if any components listed above are missing, you'll need to install them manually. Refer to the *Manually Installing the Network Components in Windows 95 and Windows 98* section of the Appendix.

**Note:** If you need to install the TCP/IP Protocol, contact your system administrator or refer to the Windows 98 documentation. Linksys does not provide technical support for the configuration or troubleshooting of the TCP/IP protocol.

9. In the Primary Network Logon box, select **Client for Microsoft Networks**.
10. To enable File and Printer Sharing, click on the *File and Printer Sharing* button, then put a check mark next to **both** boxes in the window. Click **OK**.

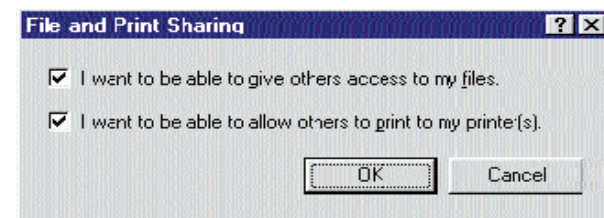





11. Click on the **Identification** tab. Type the name of your computer in the “Computer name” box. Make up a name that is unique from all the other computers' names on the network (e.g., Dino, Titus, etc.).

12. Type the name of your workgroup in the “Workgroup” box. The name you type should be the same workgroup name in use by all of the other PCs on the network. Make sure that the case and spelling of the workgroup matches what is used on your other computers.

13. Enter a description of your computer in the Computer Description box. This box is optional.
14. *Optional:* Click on the **Access Control** tab. Make sure that *Shared-level access control* is selected. If the setting is on User-Level access control and you can't change it, skip to Troubleshooting problem 5.
15. Click on the **OK** button. Your system may or may not ask you for your Windows 98 CD-ROM or the location of the 98 installation files. Direct Windows to the appropriate location, (e.g., “D:\win98”, “C:\windows\options\cabs”).

16. Once Windows is done copying the necessary files, the System Settings Change window appears. Remove all disks from your computer and click on **Yes** to restart your PC. If you don't see this window, simply restart your computer. The installation is complete. Remember to remove the Driver Disk from the floppy drive.

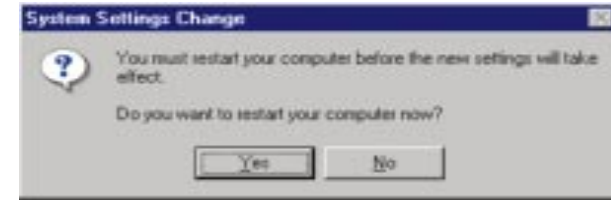

If you don't see this window, simply close down Windows 98 and restart your computer by clicking on the **Start** button, then **Shut Down**, select *Restart the Computer*, then click **Yes**. The installation is complete. Remember to remove the Driver Disk from the floppy drive.

17. Once the computer has restarted, look at the EtherFast Card's LEDs. If your cabling is properly attached and the network is detected, the green Link light will be on, and the Activity (ACT) light will be flickering or solid.
18. Once Windows is up, a Logon window will appear requiring you to enter a username and password. Make up a username and password, enter them, and click **OK**. Do not click the **Cancel** or **Esc** button, or you won't be able to log onto the network. If the logon does not appear or if it does not allow you to log on, refer to the Troubleshooting section.
19. Once you are at the Windows 98 desktop, double-click on the **Network Neighborhood** icon. You should see an icon for **Entire Network**, and the names of the other PCs on the network. In order to see other computers and shared resources in Network Neighborhood, you need to enable *File and Printer Sharing* (refer to the section titled such).
 

*If you don't see anything at all*, press the F5 key on your keyboard a few times to refresh the screen.

*If you only see your computer in Network Neighborhood*, refer to the Troubleshooting section.

*If you see all computers on the network except yours, and the other PCs can't see your computer*, refer to the Troubleshooting section.

*If you only see computers that are running the same operating system as you and you don't see any others*, refer to the Troubleshooting section.

# Windows Millennium Installation and Setup

## Overview

The instructions provided in this section will help you to install the EtherFast 10/100 PC Card on Microsoft Windows Millennium. After installing the EtherFast 10/100 PC Card hardware in your computer, follow these instructions to install the EtherFast 10/100 PC Card's Windows Millennium network driver from the card's driver disk.

**Note:** Screen shots used in this Installation and Setup section are from installation of the standard EtherFast 10/100 PC Card (PCMPC100 v3). If you are installing the EtherFast 10/100 Integrated PC Card (PCM100 v2), the installation process will be unchanged, however, the product name will be different.

## Installing the PC Card's Driver

To install the network driver, Start up your computer.

1. Start your computer. Windows will automatically detect the presence of the EtherFast 10/100 PC Card in your computer and display the *Update Device Driver Wizard* window.
2. Insert the *EtherFast 10/100 PC Card Driver Disk* into your Notebook PC's floppy disk drive and click **Next**.
3. Select the *Specify the location of the driver (Advanced)* option. Click **Next**.



4. If you are asked to supply a path for the driver, type **A:\WINME** in the drop-down box that appears and click **Next**.
5. Once Windows has located the driver, a message will appear that reads *Windows is now ready to install the Linksys EtherFast 10/100 PC Card V3 driver*. Click **Next**.



Windows will begin copying the necessary files onto your computer.

If Windows asks you to supply the original Windows ME CD-ROM, insert it now and direct Windows to the proper location for the disk (e.g., "c:\windows\options\Install" or "D:\Win9x").

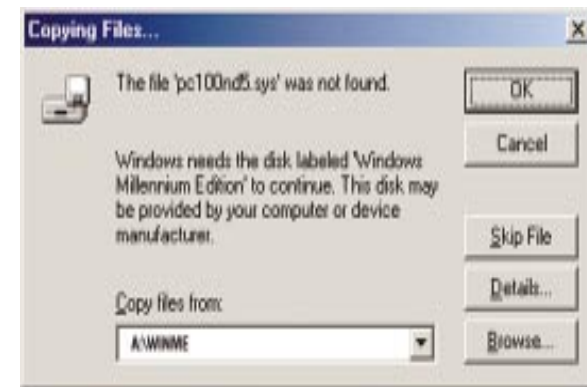

If Windows asks you to supply a driver containing the letters "pc100", enter "a:" in the *Copy Files From* box and click **Enter**.



6. When the following window appears, click **Finish**. When you are asked if you want to restart your computer, remove any Driver Disks from the floppy disk drive, click **Yes**, and allow your system to restart.



7. After Windows restarts, enter a **User Name** and a **Password** when prompted, and click the **OK** button.
8. Once you are back on the Windows desktop, you can make the necessary changes to your system's network settings by clicking on the **Start** button, then **Settings**, then **Control Panel**, then double-click the **Network** icon.

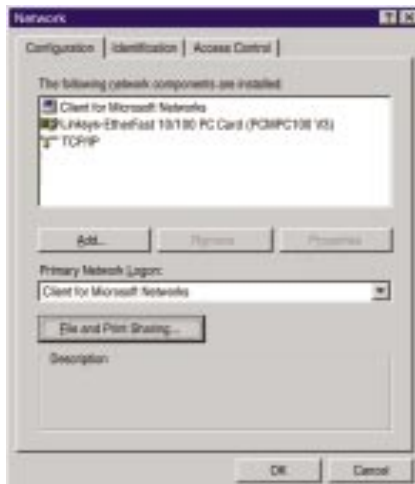

**Note:** Linksys does not provide technical support for TCP/IP configuration or troubleshooting.

9. When the above window is displayed, click on the *Configuration* tab. Confirm that all the following network components are installed:
- Client for Microsoft Networks
  - Linksys EtherFast 10/100 PC Card (PCMP100 V3)
  - TCP/IP
- To set up *File and Printer Sharing*, or to configure *Client for Microsoft Networks* or *Client for Netware Networks*, please refer to the **Appendix**.

Your EtherFast card is now successfully set up.

# Windows NT 4.0 Installation and Setup

## Overview

The following instructions will set up an NT 4.0 server/workstation on your PC. You should have your original Windows NT CD-ROM handy during the installation, as you might be asked to supply it.



**Note:** Screen shots used in this Installation and Setup section are from installation of the standard EtherFast 10/100 PC Card (PCMP100 v3). If you are installing the EtherFast 10/100 Integrated PC Card (PCM100 v3), the installation process will be unchanged, however, the product name will be different.

To install the network driver for an NT 4.0 Server or Workstation

1. **Log into Windows NT** as a network administrator.
2. Click on **Start**, **Settings**, **Control Panel**, and then double-click on the **Network** icon.
3. If you have not previously installed Windows NT networking on your computer, a message will appear that reads: *Windows NT Networking is not installed. Do you want to install it now?*

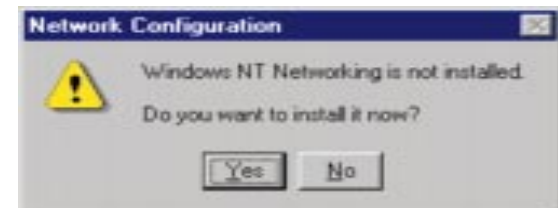

- If you see this message, click **Yes** to install NT networking along with the EtherFast Card's network driver, and continue with step 1 below.
- If you don't see this message, NT networking is already installed. Skip to the section entitled *Installing the EtherFast Network Driver if Networking is Already Installed*.

## Installing NT Networking & the EtherFast Card Driver

1. After clicking on **Yes**, the *Network Setup Wizard* window will appear.
2. Put a checkmark next to the *Wired to the network* option. Click **Next**.

3. Click on the **Select from list...** button to select a network adapter.

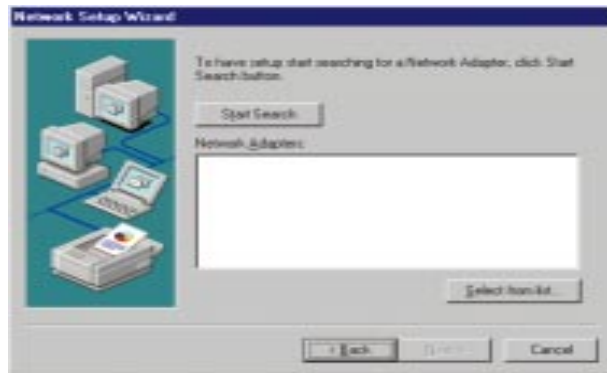

4. Select the *EtherFast 10/100 PC Card*, click on the **Have Disk** button. Insert the Driver Disk into the floppy drive. Type "A:\\*" into the box on your screen and click the **OK** button.

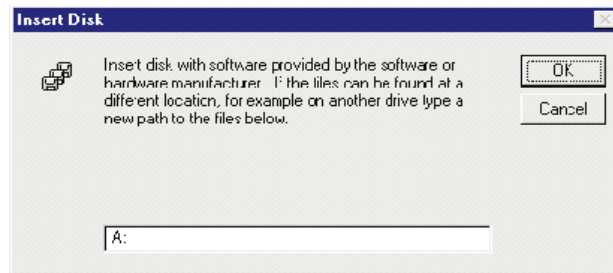

5. When the following window appears, select *Linksys EtherFast 10/100 PC Card*, click the **OK** button.

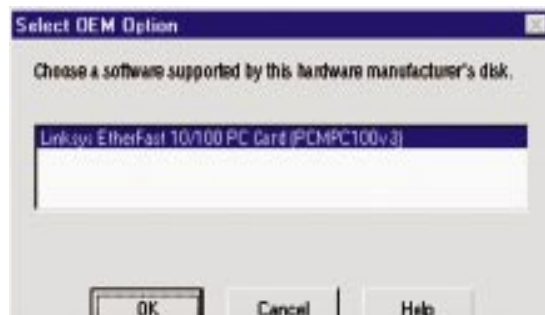

6. The adapter will be added to the list of installed Network Adapters. Click **Next**.

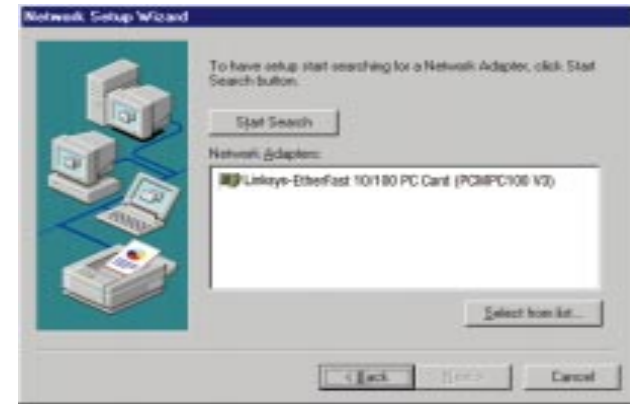

7. Place **check marks** beside each listed network protocol that you wish to install. See your Microsoft Windows NT user guide or talk to your network administrator for more information about network protocols. When you're finished, click **Next**.

**Note:** If you install the *TCP/IP protocol*, refer to your Windows NT documentation when installation steps that aren't listed in this User Guide appear. Linksys does not provide technical support for the configuration or troubleshooting of the TCP/IP protocol.

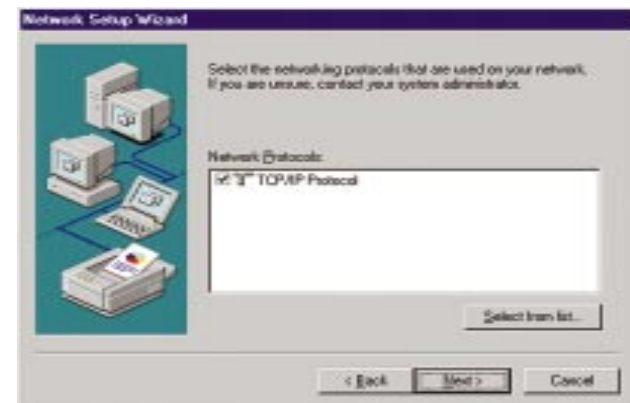

8. A list of services will appear. Click **Next** to approve these services, followed by **Next** again.

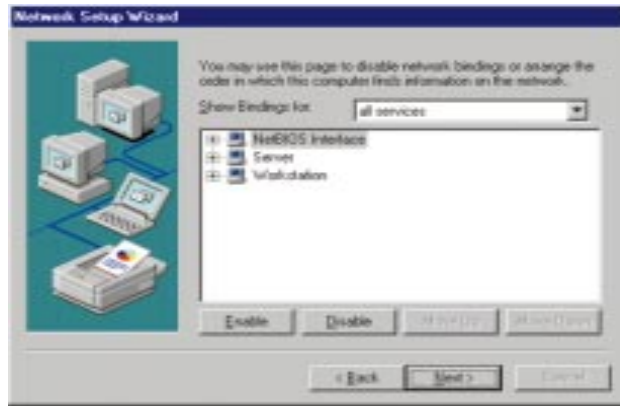

9. NT will probably ask you to supply your original Windows NT CD-ROM or setup disks. If so, place your Windows NT CD-ROM in your CD drive. If the CD-ROM loads a pop-up window, close it. Type “D:\I386” (or the appropriate CD-ROM drive letter) in the box and click **Continue**.

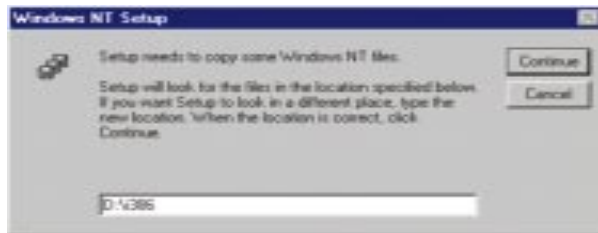

10. NT will then display a window containing several setting types. Keep the default settings unless you know that you need to change them.

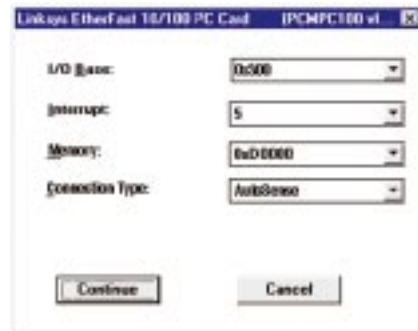

After you have made the appropriate settings, click **Continue**.

11. Windows NT will copy the necessary network drivers to your PC. When the copying is complete, you will see a list of installed bindings. Change the bindings settings if needed and click **Next**.



**Note:** For information and help on choosing your bindings, services and protocols, ask your network administrator, or check your Windows NT documentation.

12. Choose either **Workgroup** or **Domain**, depending on the type of network you're setting up. (Your NT user guide explains the difference between Workgroups and Domains.) Click the **Next** button.



A window will appear stating that *Networking has been installed on this computer*. Click the **Finish** button.

13. When asked if you want to restart your computer, remove the Driver Disk and click **Yes**.

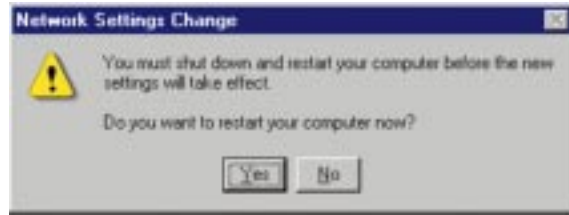

14. Once your PC has rebooted and you log on to the network, double-click the **Network Neighborhood** icon on your desktop. Make sure that you have access to the network. If you do, your card has been properly installed.

*Note: If you had previously installed any NT service packs, you must re-install them.*

**Windows NT Installation and Setup for the EtherFast 10/100 PC Card is complete. Do not continue with the next set of instructions. They are for NT users who already have their networking configured.**

## Installing the EtherFast Network Driver if Networking is Already Installed

The following steps will install the EtherFast Card's driver software on your PC, enabling your PC to properly communicate with the card. Remember that **you must be logged on as a network administrator to continue**.

1. Click on **Start, Settings, Control Panel**, then double-click on the **Network** icon.
2. When the networking window appears, choose the **Adapters** tab. Click the **Add** button.

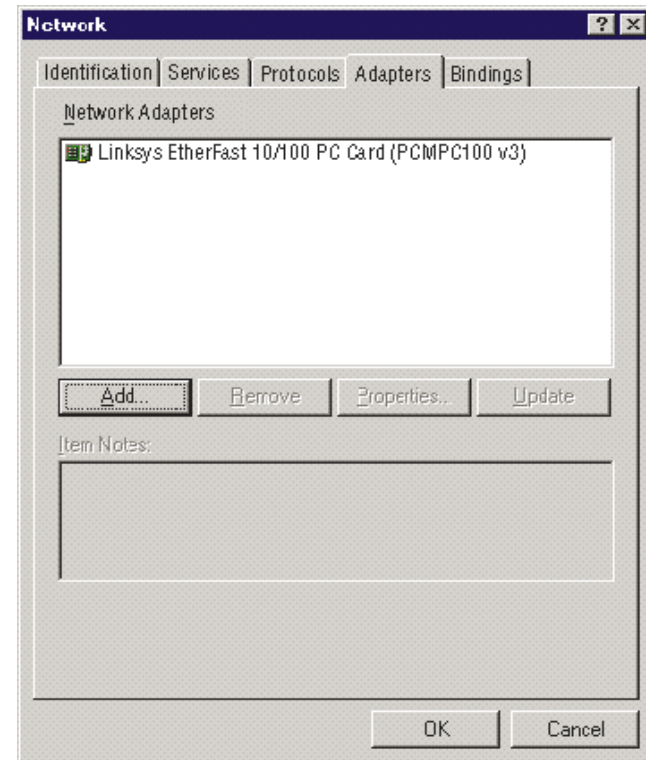

*Note: For information and help on choosing your bindings, services and protocols, ask your network administrator or check your Windows NT documentation.*

3. When the list of available network adapters appears, select *Linksys EtherFast 10/100 PC Card*. Click the **Have Disk** button.

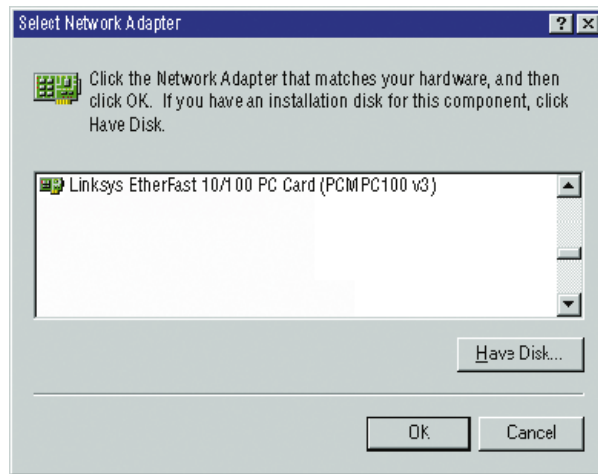

4. Put the EtherFast Card Driver Disk into drive A. Type "A:\\*" into the box on your screen and click the **OK** button.

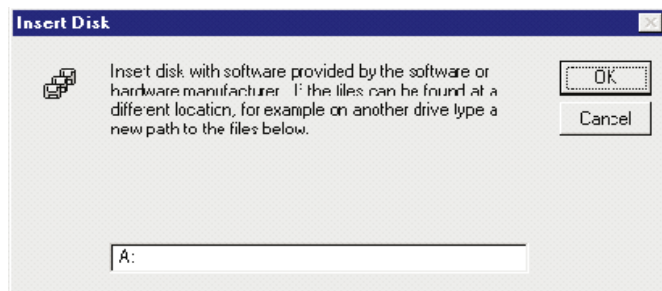

5. When the following window appears, select *Linksys EtherFast 10/100 PC Card (PCMP100 v3)*, click the **OK** button.

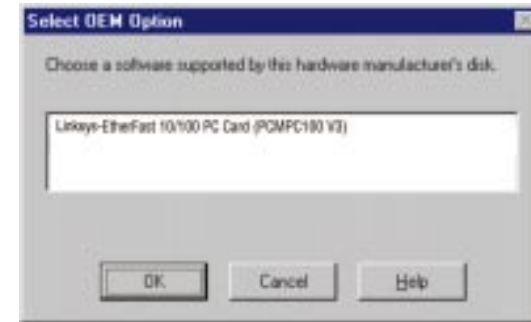

6. NT will then display a window containing several setting types. Keep the default settings unless you know that you need to change them.



After you have made the appropriate settings, click the **Continue** button.

7. If Windows NT asks you to supply your original Windows NT CD-ROM or setup disks, direct Windows NT to the proper location (e.g., D:\I386). Click the **OK** button.





8. Click on the **Protocols** tab. Add any protocols you require by clicking the **Add** button.

*Note: If you install the TCP/IP protocol, refer to your system administrator or your Windows NT documentation when installation steps that aren't listed in this User Guide appear. Linksys does not provide technical support for the configuration or troubleshooting of the TCP/IP protocol.*

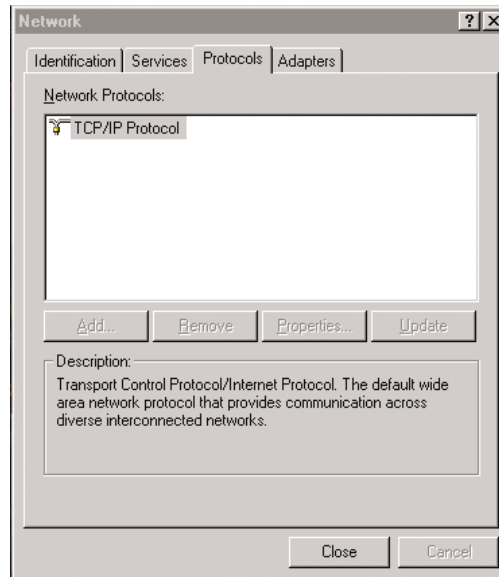

9. After your bindings, settings, and services are set, click the **Close** button.

- 10 The Network Settings Change box will appear. Remove your Driver Disk and click the **Yes** button to restart your PC.

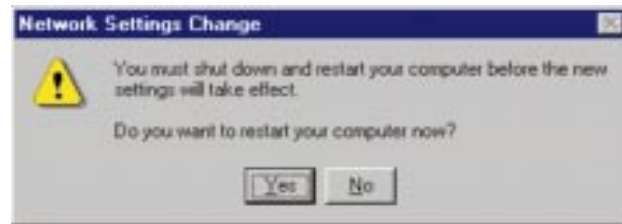

11. Once your PC has rebooted, double-click the **Network Neighborhood** icon on your desktop. Make sure that you have access to the network. If you do, your card has been properly installed.

*Note: If you had previously installed any NT service packs, you must re-install them.*

**The Windows NT EtherFast Card Installation and Setup is complete.**

# Windows 2000 Installation and Setup

## Overview

After physically installing the EtherFast PC Card in your computer, follow these instructions to install the network driver.



*Note: Screen shots used in this Installation and Setup section are from installation of the standard EtherFast 10/100 PC Card (PCMP100 v3). If you are installing the EtherFast 10/100 Integrated PC Card (PCM100 v3), the installation process will be unchanged, however, the product name will be different.*

1. Windows 2000 will automatically recognize your EtherFast PC Card.

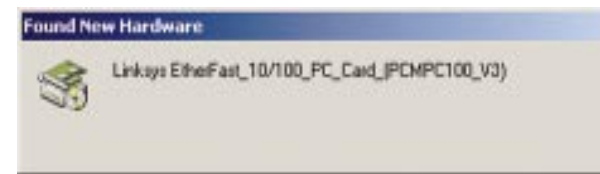

2. Windows will then display the *Found New Hardware Wizard* Screen. Click **Next**.





3. Windows will display the installation screen next. Make sure that the radio button next to *Search for a suitable driver for my device (Recommended)* is filled in. Click **Next**.



4. When the **Locate Driver Files** box is displayed, put a check in the box next to Floppy disk drives. Place your driver disk into the floppy drive and click **Next**.

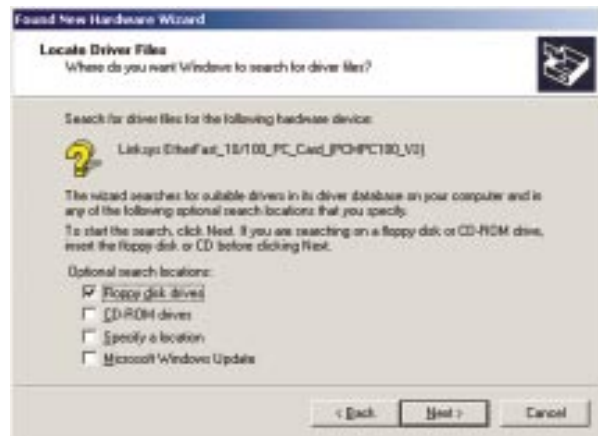

5. Windows should display the **Driver Files Search Results** box. Note that the driver shown in the box is in the path *a:\netpc100.inf*. If it is, click **Next**. Windows will begin to copy the installation files from your floppy disk.



6. Windows may display the following box next. If so, click **Yes**.



7. After copying all the files, Windows will display the following screen. This screen means that the device driver has been properly installed.

Click the **Finish** button. Your installation is complete. If you want to share files or printers, refer to the Windows 2000 documentation.



## Troubleshooting

- Windows doesn't detect new hardware with the EtherFast Card hardware installed, or it continues to detect the card each time you restart your PC.
  - You might not have inserted the PC card correctly or securely into the appropriate slot of your computer. Check that the card is securely inserted into the appropriate slot.
  - Try inserting your card into an alternate PC slot.
  - You may have previously aborted a new hardware setup. Check your device manager and remove the EtherFast Card (if shown) or any unknown devices. Then, follow the instructions in the *Starting Over in Windows 95, 98, or 2000*.
- Windows can't locate the driver for the EtherFast Card device.
  - You may have inserted the wrong diskette into your PC's drive.
  - The diskette may be defective or files may be missing. Make sure the disk has a few files in a:\ starting with "pc100" or a folder called "Win95" for Windows 95 or "Win98" for Windows 98.
- The Windows Logon screen doesn't appear after you restart your computer.
  - Click on Start, Shut Down, then Close All Programs and Logon as a Different User, (in Windows 98, select *Log Off*). If this doesn't solve the problem, your PC's manufacturer may have disabled Windows' networking. Contact your computer's manufacturer for help.
  - Check in the *Device Manager* to verify the network card is properly installed.
- After entering a username and password, a window appears that reads, "No Domain Server could be found to validate your Username and Password."
  - Click on **Start, Settings, Control Panel**. Double-click on **Network**. Click on the **Configuration** tab. Under *The Following Network Components are Installed* box, highlight *Client for Microsoft Networks* and click on the **Properties** button. Once you are in the *Client For Microsoft Networks Properties* window, make sure that *Log on to Windows NT Domain* is unchecked. Once you have made sure that it is unchecked click on the **OK** button and restart your computer.

5. On the Access Control Tab, User Level Access is selected, but Shared Level Access is grayed out and not accessible.
  - You previously had your primary network logon set to *Client for NetWare Networks*. On the **Configuration** tab of the *Network Properties* window, ensure that your primary network logon is set to *Client for Microsoft Networks*.
  - Your personal web server PC or Microsoft Front Page may require you to choose a user level for security reasons.
6. In Network Neighborhood you can only see your self and no other computers on the network.
  - Make sure that the cables are connected correctly. Make sure you are getting Link or Activity lights on both the EtherFast Card and your hub. Try changing to a new cable that you know is working, or use a different port on the hub.
  - Your workgroup name may be different from other computers on your network. Make sure each PC on the network is using the same workgroup name and protocol.
7. In Network Neighborhood, you can see all other computers on the network but not yourself, and all other computers can see each other and not your computer.
  - You may have not have enabled *File and Printer Sharing*. To do so, go to step 8 on page 13 for Windows 95, or step 10 on page 19 for Windows 98.
  - The network card might not be setup properly. Try reinstalling the card's drivers. To clean your system of the old installation, go to the section *Starting Over in Windows 95, 98, or 2000* in the Appendix.
8. Network Neighborhood is Empty.
  - Verify that your Microsoft Client is installed. See the Windows 95 or 98 setup instructions in this guide for directions. Verify that you have logged in correctly.
9. You receive DHCP Errors in Windows.
  - If you are connecting to a DHCP server, check your cabling and connection. If you require TCP/IP to be configured, check with your network administrator or your Windows documentation for proper settings.
  - If you don't have a DHCP server on your network, you may remove the TCP/IP component from Windows' networking if your network doesn't require it. To do this, click on Start, Settings, Control Panel, then double-click on Network. Click once on the component entry with the words TCP/IP and Linksys or TCP/IP on its own, then click on the Remove button. Click **OK** when finished and restart your PC.

10. In Network Neighborhood you can only see computers running the same operating system as your computer (i.e., your PC is running Windows 95 and it can only see other Windows 95 computers and not any computer running Windows 98).
  - Choose **Start, Find, Computer** and type the name of the computer in the window that comes up and click Find Now.
  - Now make sure that the you are using the same protocol(s) and workgroup name on the 95 and 98 computers. To do this, click **Start, Settings, Control Panel** on two computers running different Windows operating systems. Click on the **Network** icon, choose the **Configuration** tab. Compare the protocols on both computers and make sure that they are the same. If any protocols are missing, refer to your Windows documentation to install any needed protocol(s).
  - If all computers are using the same protocol(s) and Workgroup name (in **Identification** tab), and Windows 95 computers can't see Windows 98 computers, enable NetBIOS on all the computers using Windows 95 and 98. Follow these instructions:
  - The IPX/SPX-compatible protocol should be installed on all Windows computers. Refer to your Windows documentation if this protocol is not installed. Bring up the properties of the IPX/SPX-compatible protocol by clicking on **Start, Settings, Control Panel**, then double-click the **Network** icon. Choose the *Configuration* tab and highlight *IPX/SPX-compatible Protocol*. Click on **Properties**. Now, to install NetBIOS, click on the *NetBIOS* tab. Put a check next to *I want to enable NetBIOS over IPX/SPX*. Click **OK**, then **OK** again. Windows will copy the appropriate files to your computer. When asked to restart your PC, remove any floppy disks and click **OK**. Be sure to do this on all of your computers that are having trouble seeing your entire network.

# Appendix

## Sharing Your Files and Printers

### Overview

By sharing your files and printers, other PCs on your network will be able to access the resources on your PC.

Before sharing your files and printers, you should prepare your computer to be used with any file servers that may be on the network. If you are **not** using Windows 95 or Windows 98 with an NT or NetWare file server, or if you are not sure if you have a file server, continue below.

If you are using a NetWare or NT file server, review page 45 or 46, respectively, for client setup.

### Enabling File Sharing

1. On your Desktop, double-click your **My Computer** icon. A window of available disk drives will appear.
2. Using your right mouse button, click once on the drive or folder that you want to make available to other users.
3. Click on **Sharing**, followed by the **Sharing** tab. Click on **Share As**.
4. In the *Share Name* box, enter a name for the drive or folder you are sharing. This can be any drive on your PC—floppy drive, hard drive, CD drive, zip drive, etc.
5. Decide on the type of access that you want to give other users.

- **Read-Only access** lets other users view the files on the selected drive.
- **Full access** lets users create, change, or delete files on the selected drive.
- **Depends on Password** lets users have Read-Only and/or Full access to the selected drive, depending on the password that you decide to give them.

**Note:** If you are only using your PC to access the Internet, it is highly recommended that you use passwords for your shares.

6. If you want to assign access passwords, type the passwords into the *Password* boxes.
7. When you're done, click on the **Apply** button, followed by **OK**. Repeat steps 1-7 for any drive or folder you desire to share on the network.

**You have successfully enabled File Sharing on your PC. Your selected drives can now be accessed by other network users. If a user tries to access one of your password-protected drives or folders, he or she will be asked for the appropriate Read-Only or Full-Access password. Continue on if you wish to share your PC's printer over the network.**

### Enabling Printer Sharing

1. On your Desktop, double-click on the **My Computer** icon.
2. Double-click the **Printers** folder. A window of available printers will appear.
3. Using your right mouse button, click once on the printer that you want to share with other users. Click on **Sharing**, followed by the **Sharing** tab.
4. Click on **Share As**. In the Share Name box, give a name to the printer you want to share. If you want to assign a password to the printer so that only certain users can access it, type a password in the *Password* box.
5. Click on the **Apply** button, followed by **OK**. Your printer(s) are now shared.

**Note:** Not all printers may be shared on the network. Others may require special instructions. Refer to your printer's user guide or contact your printer manufacturer if you think this may be the case with your printer.

**The Printer Sharing setup and installation is complete. Your printer can now be accessed by other network users. The printer's driver may have to be installed on other PCs. Consult your printer's documentation.**

## Novell NetWare 3.x Client Setup for windows 98 or 95

The instructions below explain how to set up the regular Novell NetWare 3.x client for use on a Windows 98 or 95 PC.

1. Follow the Windows 95 setup instructions or the Windows 98 setup instructions.
2. Start up Windows 95 or 98. Click on **Start, Settings**, then **Control Panel**. Double-click on **Network**. The *Network* window appears. Click on the **Configuration** tab.
3. Make sure that *Client for Microsoft Networks* and *Client for Netware Networks* are listed. If either are missing, you will have to install them manually. Refer to *Manually Installing Network Components in Windows 98 and 95* in the Windows 98 Installation section.
4. In the **Primary Network Logon** box, choose *Client for NetWare Networks*.
5. Under the *The following network components are installed* box, highlight *Client for NetWare Networks* and click on the **Properties** button.
6. The *Client for NetWare Networks Properties* window appears. Under the **General** tab, enter the name of your network's Preferred Server. *Assign the First Network Drive Letter*; the default is F. If available, make sure the **Enable** logon script processing is checked. Click **OK**.
7. Click on the **Access Control** tab. Make sure the *Share-level access control* option is selected; do not select *User-level access control*.
8. When you're done, click **OK** to restart your computer.

**The NetWare portion of your Windows setup is complete.**

## Windows 98 or 95 Client for windows NT

If you are installing the EtherFast 10/100 PC Card in a Windows 95 or 98 PC that you plan on logging into a NT domain server, follow the directions below.

1. Follow the Windows 95 setup instructions or the Windows 98 setup instructions
2. Start up Windows. Click on **Start, Settings**, then **Control Panel**. Double-click on **Network**. The *Network* window appears. Click on the **Configuration** tab.
3. In the **Primary Network Logon** box, choose *Client for Microsoft Networks*, which instructs your PC to log into an NT 4.0 server where you already have a username and password set up.
4. Under the the following network components are installed box, highlight *Client for Microsoft Networks* and click on the **Properties** button.
5. The *Client for Microsoft Networks Properties* window will appear. Under the **Logon Validation** box, make sure that *Log on to Windows NT* domain is checked. Enter the name of your domain into the **Windows NT Domain** box. Click **OK**.
6. *Optional*: Click on the **Access Control** tab. Make sure that *Share-level access control* is selected; do not choose *User-level access control*. If *Access Control* is grayed out and cannot be selected, refer to the *Troubleshooting* section.
7. When you're done, click **OK**. When asked if you want to restart your PC, choose to do so.

**The NT portion of the Windows setup is complete.**



## Starting Over in Windows 95 and 98

If you experience installation difficulties, you may need to re-install all of the Windows networking components from scratch. The instructions below explain how to give your PC a clean sweep so that you can start the EtherFast Card's software installation over.

1. At the desktop click on the **Start** Button, highlight **Settings**, click on **Control Panel**.
2. Double-click on the **Network** Icon.
3. If the *Configuration* box has a component called *Dial-Up Adapter*, skip forward to step 5. If it doesn't, continue with step 4.

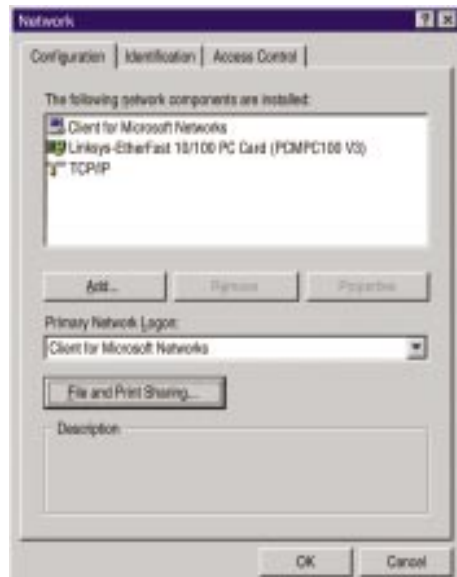

**Note:** Screen shots are for demonstration purposes only. Actual product and adapter names may vary depending on which product you are installing.

4. Remove any instance of the name *Linksys* in the box. This includes *IPX/SPX...Linksys*, *NetBEUI...Linksys*, and *TCP/IP...Linksys*. Also remove *Client for Microsoft Networks*, *Client for NetWare Networks*, and *File and Printer Sharing for Microsoft Networks*.

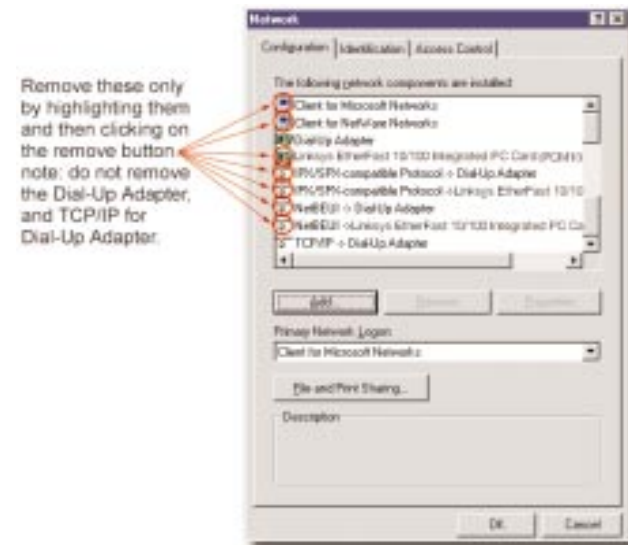
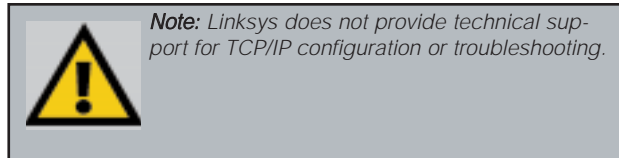

In some cases, removing one of these components may in turn automatically remove other components as well. If this happens, skip ahead to step 6.

5. For PCs with Dial-Up Networking and/or an AOL adapter, remove any instance of the name *Linksys*, all *IPX/SPX* protocols, all *NetBEUI*, all *Clients*, and *File and Printer Sharing for Microsoft Networks*. Do **not** remove *Dial-Up Adapter*, *AOL Adapter*, *TCP/IP-Compatible Protocol-AOL Adapter* or *TCP/IP-Compatible Protocol-Dial-Up Adapter*.
6. When you are done removing all the unnecessary components, click **OK**. When asked to restart, click **No**.



- Return to the *Windows Control Panel*. Double-click on the **System** Icon. The *System Properties* window will appear. Click on the **Device Manager** Tab.

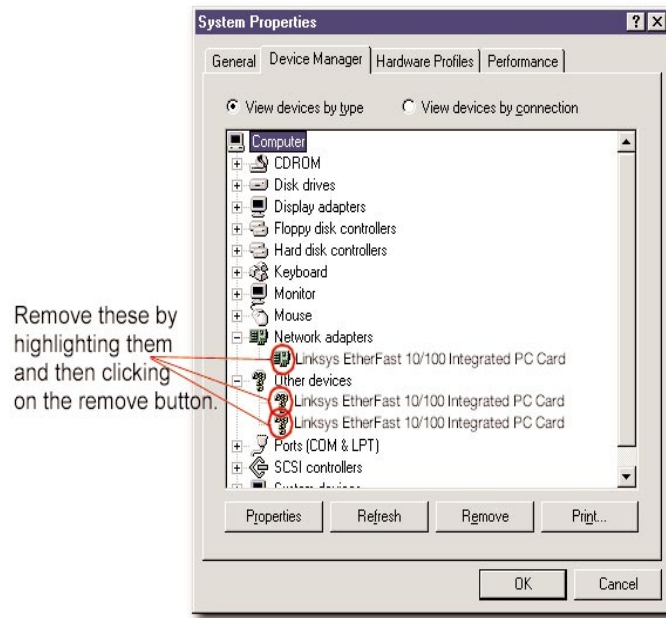

- Scroll down to the *Network Adapters* item and expand it by clicking on the **open** [+] sign.
- Remove all devices with the name *Linksys* in its description. (If at any point you are asked to restart the computer, Click **No**).
- Scroll down to the *Other Devices* section. Remove all devices with *Linksys*, *EtherFast*, or *PCMP100* in the name. (If Other Devices is not listed, proceed to the next step.)
- When you're finished, click on the **Close** button, shut down Windows, and restart your computer.
- After your computer has restarted, turn to the section called *Windows 95 Installation and Setup* or *Windows 98 Installation and Setup*, whichever is appropriate for your computer. Follow the setup instructions.

## Starting Over in Windows 2000

- Click the **Start** button, choose Settings, choose Control Panel, then double-click the System icon. The System Properties window will open.



- Choose the Hardware tab.
- Click the Device Manager button. The Device Manager window will open.

- Click the plus sign (+) beside Network Adapters. The *Linksys EtherFast 10/100 PC Card* listing should appear.
- Right-click on *Linksys EtherFast 10/100 PC Card*. A menu box should open. Choose **Disable**.
- When asked if you want to Disable the device, click Yes.



8. Right-click on the *Linksys EtherFast 10/100 PC Card* again. This time, select **Uninstall**. The following screen will appear. Click the **OK** button.

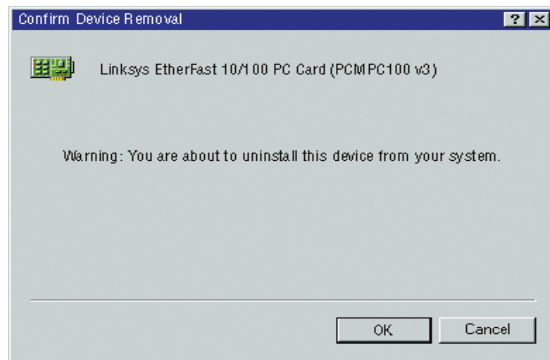

9. The Network Adapters category should be removed from the Device Manager listing.
10. Click the **OK** button, and restart your computer.

## Manually Installing Network Components in Windows 95 and 98

There may be times when you might need to manually install missing Windows networking components.

1. Click on **Start, Settings**, then **Control Panel**.
2. Double-click the **Network** icon. The *Network* window appears.
3. Click on the **Configuration** tab. Make sure that the following network components are installed.
  - *Client for Microsoft Networks*
  - *Linksys EtherFast 10/100 PC Card (PCMP100 v3)*
  - *TCP/IP*

There may be other components listed in addition to the ones shown above. If any of the above components are missing, add them as follows.

### Client for Microsoft Networks

If you plan on connecting to an NT file server or peer-to-peer network, click on the **Add** button. Highlight *Client* and click on **Add**. Choose Microsoft as the manufacturer in the *Network Client* box. Highlight *Client for Microsoft Networks* and click **OK**.

### TCP/IP

Click on the **Add** button. Select *Protocol*, then click **Add**. Under *Manufacturer*, highlight **Microsoft**. Under *Network Protocol*, highlight **TCP/IP**. Click **OK**.

If you install the TCP/IP protocol, refer to your Windows NT documentation when installation steps that aren't listed in this User Guide appear.

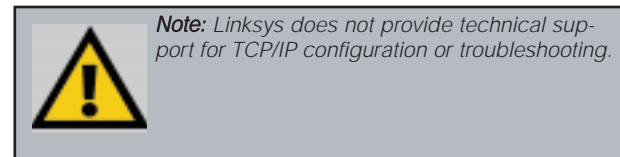

## Linux, Open Source and Beta Operating Systems

Linksys does not provide technical support for **Linux**, **BSD**, or other free-ware, Beta, or open source operating systems. Although many Linksys products have been proven to perform well under Linux and other freeware Operating Systems, technical support for setup and troubleshooting is not provided. For information on where to find device drivers and setup instructions for Linux and other freeware Operating Systems, visit the support pages and FAQ files on the Linksys website at [www.linksys.com](http://www.linksys.com).



**Note:** After manually installing a component, you will be asked to reboot your computer. **Do not** reboot until after you have finished installing all desired components.

## Twisted-Pair Cabling

There are different grades, or categories, of twisted-pair cabling. Category 5 is the most reliable and is highly recommended. Category 3 is a good second choice. Straight-through cables are used for connecting computers to a hub. Crossover cables are used for connecting a hub to another hub (there is an exception: some hubs have a built-in uplink port that is crossed internally, which allows you to link or connect hubs together with a straight-through cable instead).

You can buy pre-made Category 5 cabling, or cut and crimp your own.

RJ-45 Color Chart	
Wire 1	White with an Orange Stripe
Wire 2	Orange
Wire 3	White with a Green Stripe
Wire 4	Blue
Wire 5	White with a Blue Stripe
Wire 6	Green
Wire 7	White with a Brown Stripe
Wire 8	Brown

Category 5 cables can be purchased or crimped as either straight-through or crossover cables. A Category 5 cable has 8 thin, color-coded wires inside that run from one end of the cable to the other. All 8 wires are used. In a straight-through cable, wires 1, 2, 3, and 6 at one end of the cable are also wires 1, 2, 3, and 6 at the other end.

straight-through cable		crossover cable	
Wire	Becomes	Wire	Becomes
1	1	1	3
2	2	2	6
3	3	3	1
6	6	6	2

In a crossover cable, the order of the wires change from one end to the other: wire 1 becomes 3, and 2 becomes 6. See the diagrams on the next page for more detailed information on straight-through and crossover cabling.

information on straight-through and crossover cabling.

To determine which wire is wire number 1, hold the cable so that the end of the plastic RJ-45 tip (the part that goes into a wall jack first) is facing away from you. Face the clip down so that the copper side faces up (the springy clip will now be parallel to the floor). When looking down on the copper side, wire 1 will be on the far left.

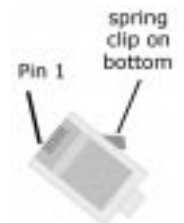

## Crimping Your Own Network Cables

### • Straight-Through Cabling

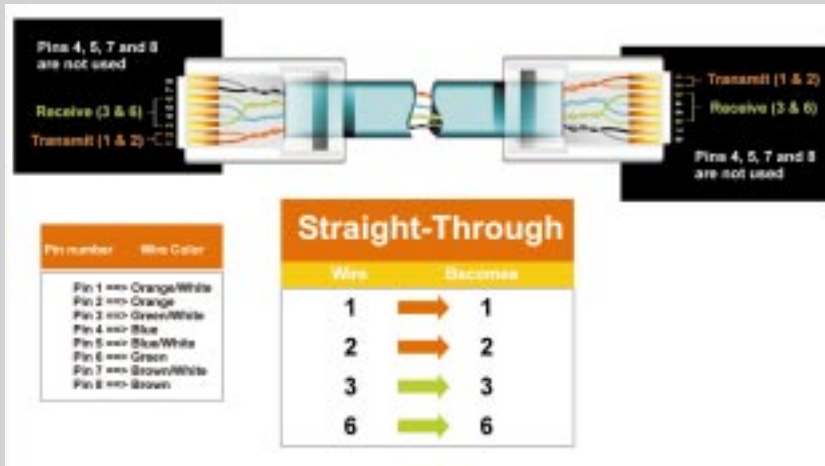

### • Cross-Over Cabling

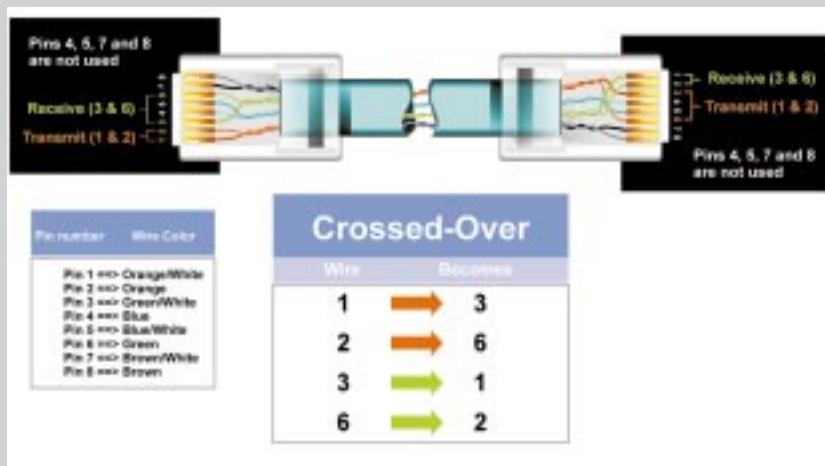

## 10/100 PC Card Specifications

Model Number:	PCMPC100 v3
System:	PCMCIA-compliant PC
Standards:	IEEE 802.3, IEEE 802.3u, PCMCIA
Ports:	One 10BaseT/100BaseTX Auto-Sensing Port
Speed	
<i>Half Duplex:</i>	10Mbps or 100Mbps
<i>Full Duplex:</i>	20Mbps or 200Mbps
Cabling:	UTP Category 5 (or better)
Topology:	Star
LED Status Lights:	Link, Activity, 10/100 Mbps (on coupler)

## 10/100 PC Card Environmental

Dimensions:	3.4" x 2.1" x 0.2" (86mm x 53mm x 5mm)
Unit Weight:	1.7 oz. (53g)
Power:	3V, 180mA, 30mA Sleep Mode
Certifications:	FCC Class B, CE Mark Commercial, UL and CSA Listed
Operating Temperature:	32°F to 122°F (0°C to 49°C)
Storage Temperature:	-4°F to 158°F (-20°C to 70°C)
Operating Humidity:	10% to 85% Non-Condensing
Storage Humidity:	5% to 90% Non-Condensing

## 10/100 Integrated PC Card Specifications

Model Number:	PCM100 v3
System:	PCMCIA-compliant PC
Standards:	IEEE 802.3, IEEE 802.3u, PCMCIA
Ports:	One 10BaseT/100BaseTX Auto-Sensing Port
Speed	
<i>Half Duplex:</i>	10Mbps or 100Mbps
<i>Full Duplex:</i>	20Mbps or 200Mbps
Cabling:	UTP Category 5 (or better)
Topology:	Star
LED Status Lights:	Link, Activity, 10/100 Mbps

## 10/100 Integrated PC Card Environmentals

Dimensions:	4.7" x 2.6" x 0.75" (119mm x 66mm x 19mm)
Unit Weight:	1.8 oz. (56g)
Power:	3.3V, 100Mbps 240mA max; 10Mbps 170mA, max.
Certifications:	FCC Class B, CE Mark Commercial UL and CSA Listed
Operating Temperature:	32°F to 122°F (0°C to 49°C)
Storage Temperature:	-4°F to 158°F (-20°C to 70°C)
Operating Humidity:	10% to 85% Non-Condensing
Storage Humidity:	5% to 90% Non-Condensing

## Linksys Warranty Information

Linksys guarantees that every EtherFast 10/100 PC Card is free from physical defects in material and workmanship under normal use for FIVE years from the date of purchase. If the product proves defective during this warranty period, contact Linksys Customer Support to obtain a Return Authorization Number. When returning a product, mark the Return Authorization Number clearly on the outside of the package and include your original proof of purchase.

IN NO EVENT SHALL LINKSYS' LIABILITY EXCEED THE PRICE PAID FOR THE PRODUCT FROM DIRECT, INDIRECT, SPECIAL, INCIDENTAL, OR CONSEQUENTIAL DAMAGES RESULTING FROM THE USE OF THE PRODUCT, ITS ACCOMPANYING SOFTWARE, OR ITS DOCUMENTATION. LINKSYS

OFFERS NO REFUNDS FOR ITS PRODUCTS. ALL CUSTOMERS LOCATED OUTSIDE OF THE UNITED STATES OF AMERICA AND CANADA SHALL BE HELD RESPONSIBLE FOR SHIPPING AND HANDLING CHARGES. PLEASE CALL LINKSYS FOR MORE DETAILS.

**Note:** You must have your proof of purchase and a barcode from the product's packaging on hand when calling. Return requests can not be processed without proof of purchase.



**Tampering with or disassembling this product voids its warranty.**

Linksys makes no warranty or representation, expressed, implied, or statutory, with respect to its products or the contents or use of this documentation and all accompanying software, and specifically disclaims its quality, performance, merchantability, or fitness for any particular purpose. Linksys reserves the right to revise or update its products, software, or documentation without obligation to notify any individual or entity.



<http://www.linksys.com>

© Copyright 2001 Linksys, All Rights Reserved.